



# WoodEvo EvoClad

## CASTELLATED WALL CLADDING INSTALLATION GUIDE

When installing WoodEvo™, always comply with local building codes. These instructions are for illustration purpose only and not meant to replace the expertise of a licensed professional. WoodEvo™ assume no responsibility for any risks and liability associated with the use of WoodEvo™ products during construction.



### SAFETY WARNING

Wearing safety equipment is required during any type of construction work. When working with WoodEvo™ composite cladding, you should wear gloves, respiratory protection, long sleeves and safety glasses. Standard woodworking tools can be used. When installing WoodEvo™, always comply with local building codes. While on a construction site, it is necessary to wear appropriate safety equipment to avoid the risk of injuries.

**WoodEvo EvoClad must be installed in accordance with applicable building standards, regulations and EvoClad installation guidelines.**

- ✔ Boards are never to be butt joined.
- ✔ WoodEvo Evo Cladding must be supported by a BCA compliant structure. It is not intended for use as columns, support posts, beams, joist stringers or any other primary load-bearing members.
- ✔ It is the designer / builders responsibility to ensure that all components comply with the requirements of relevant standards and the BCA.
- ✔ A waterproof membrane / system has to be installed in accordance with BCA requirements.
- ✔ There must be ventilation / drainage designed to allow water flow.
- ✔ Internal walls must be levelled before cladding installation. Batten size and position need to be considered according to window reveals and design of the finished trims.
- ✔ Failure to use EvoClad screws will void the warranty.
- ✔ Failure to provide gaps for expansion and contraction will void the warranty.

#### **STEEL SUBFRAME: THERMAL BREAK**

The Building Code of Australia states that both residential and commercial buildings must have a thermal break, consisting of a material with an R-Value of not less than 0.2, installed between the external cladding and any metal frame.

# Parts and Accessories

## 1. Castellated wall cladding

Dimension
26mm x 219mm x 2900mm
26mm x 219mm x 3600mm

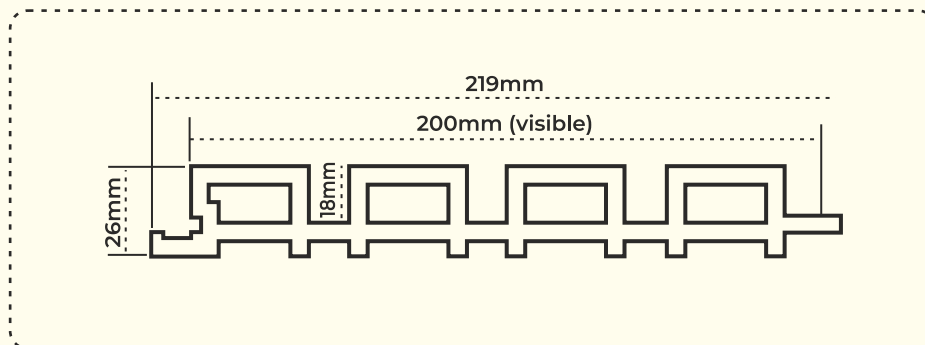

## 2. Start / end trim

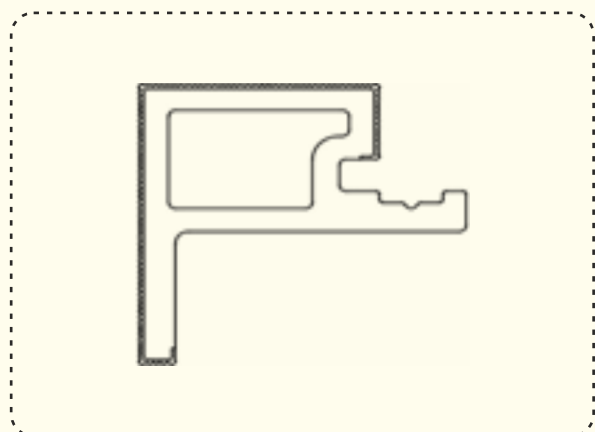

## 3. External Corner trim

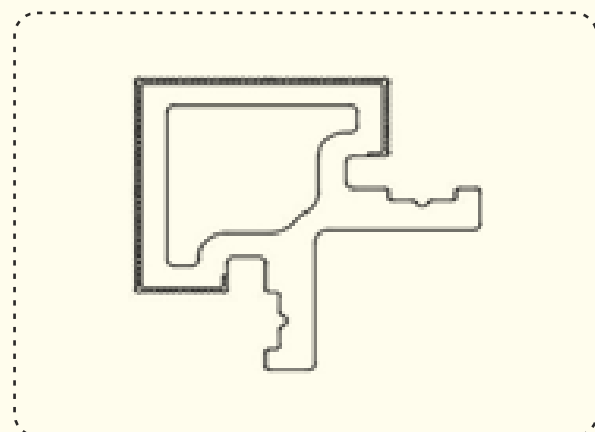

#### 4. Timber frame EvoClad Screws / Metal frame EvoClad Screws m7 x 35mm

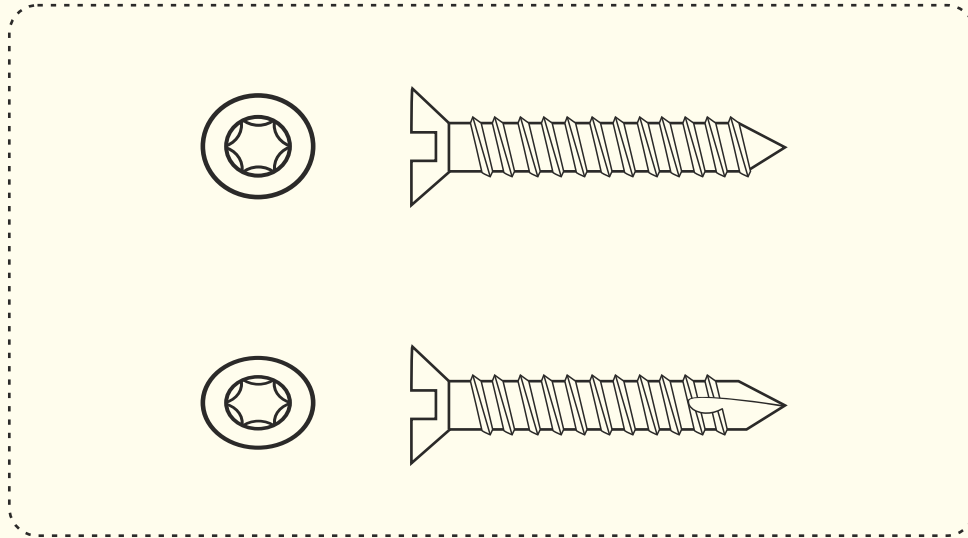

## Important Notes (Read before installation)

# Gaps

Leave at least 5mm gap to the top and bottom trim of the building or building/window flashing

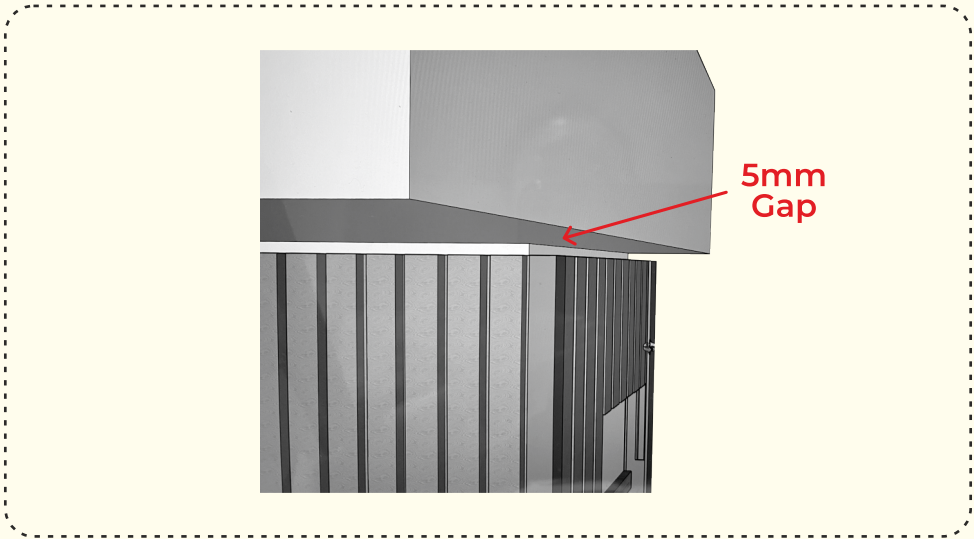

Leave at least 3mm gap on the internal corners

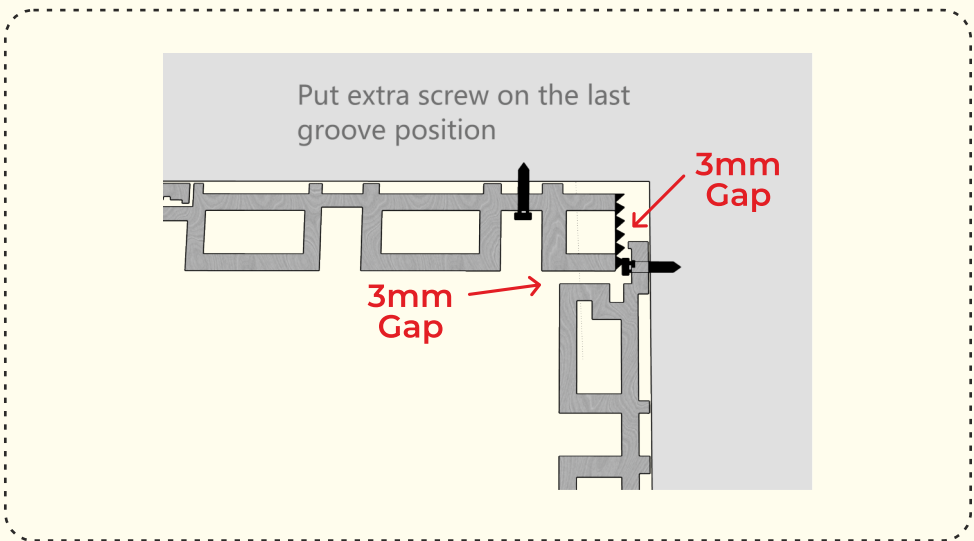

# Wall Battens

Battens have to be installed in order to install wall cladding  
500mm maximum centre to centre Batten space  
Minimum 35mm thickness timber or metal Battens

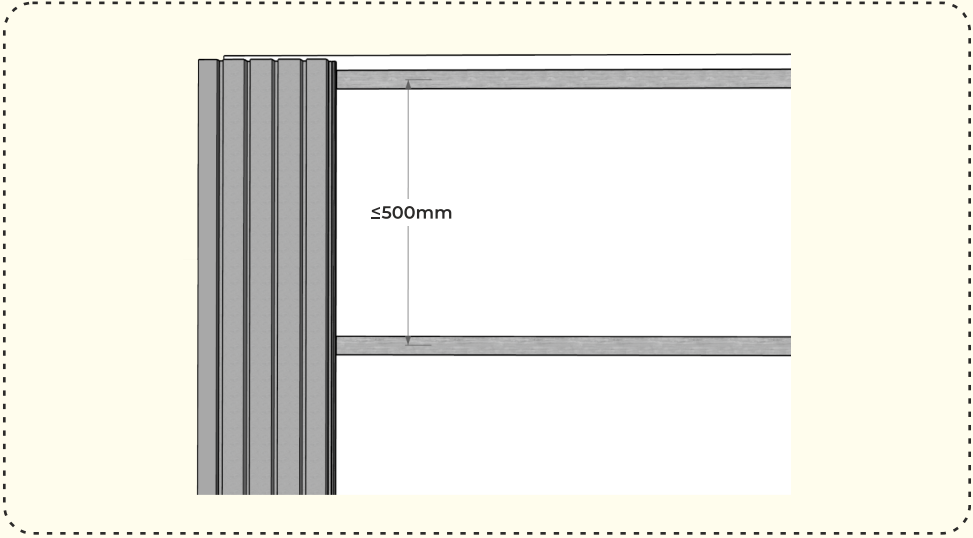

# Pre Drill

It requires 4mm pre drill on both of the wall cladding and trims before install the EvoClad screws

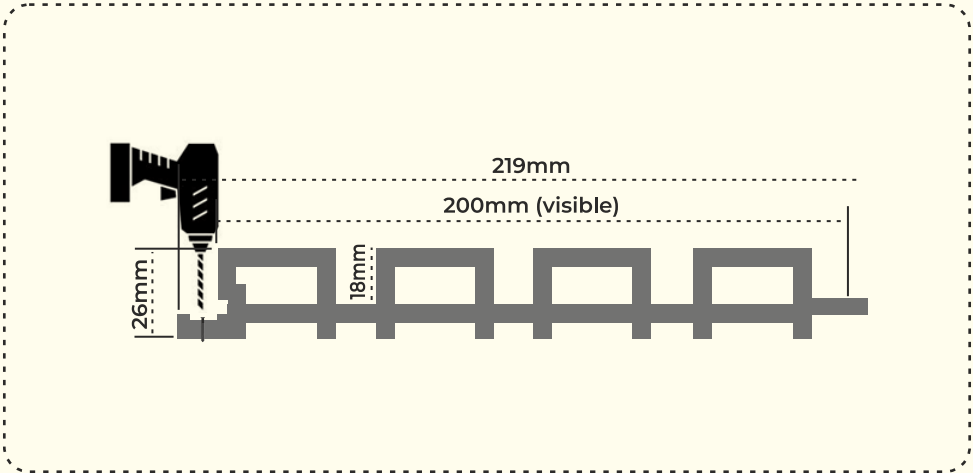

# Installation

**Notes:**

If there is Outside corner, always start from outside corner using corner trim

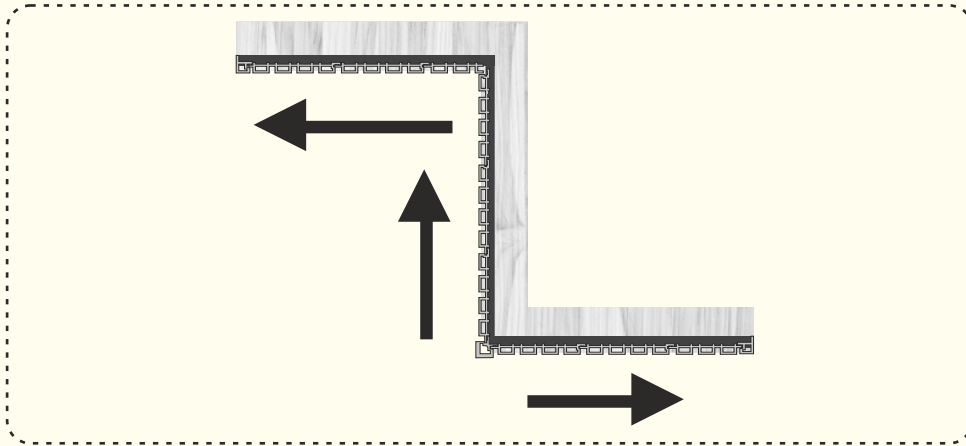

If there is inside corner but no outside corner, start from one side of the wall using start / end trim and finish by covering start/end trim

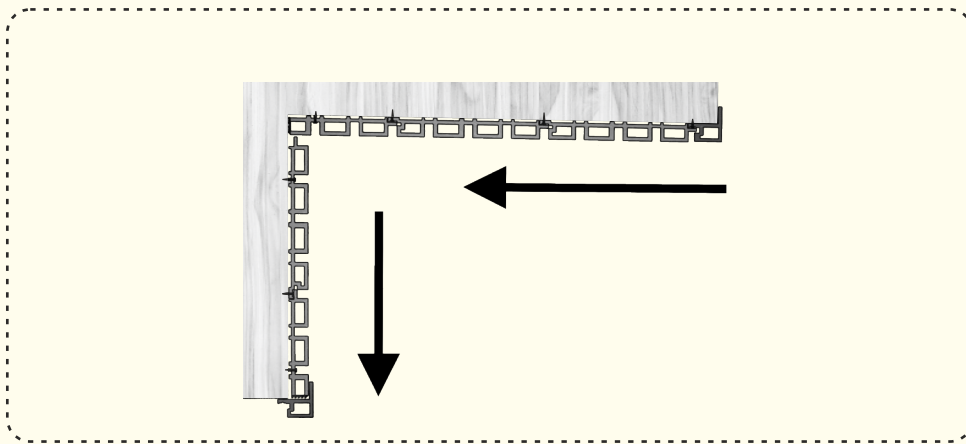

If there is no corners, start from either end of the wall

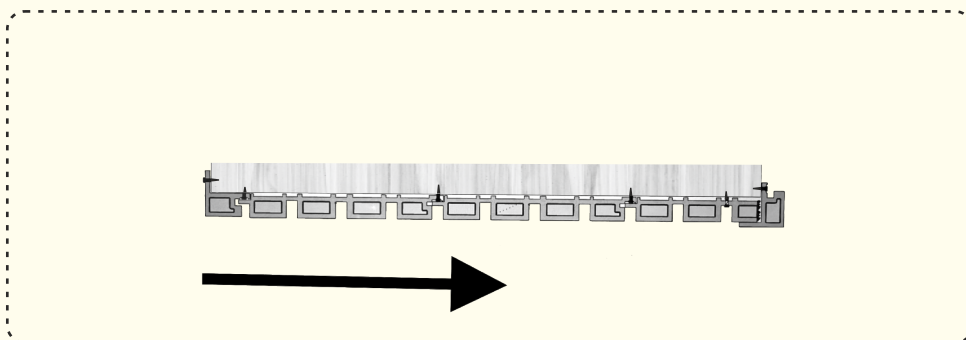

# Main Installation picture with details

Notes:

If there is Outside corner, always start from outside corner using corner trim

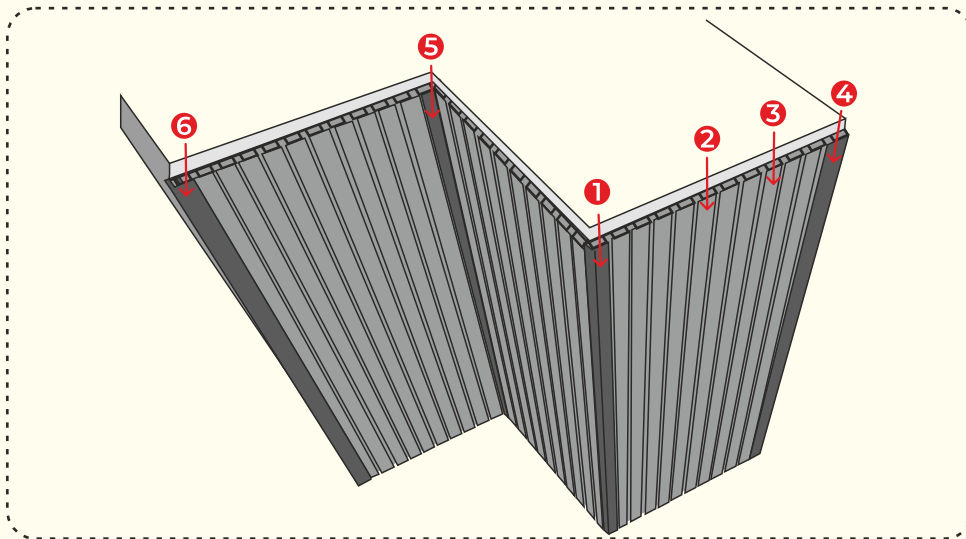

1

“Start from external corner, screw on both side of the channel to the battens”

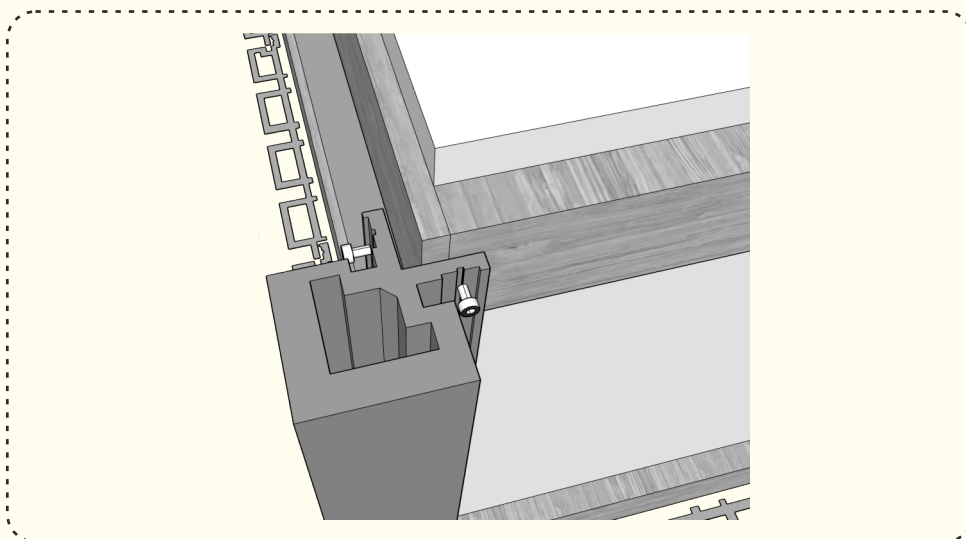



2

Slide the first board in, put the tongue into the groove of the corner trim

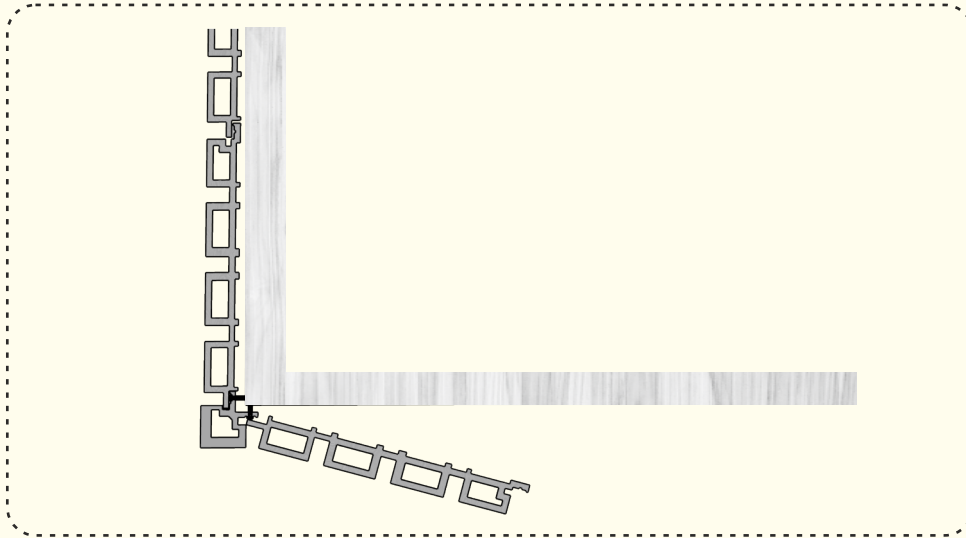

3

Fixing the first panel by put screw into the screw channel, slide the second board in, repeat untill complete

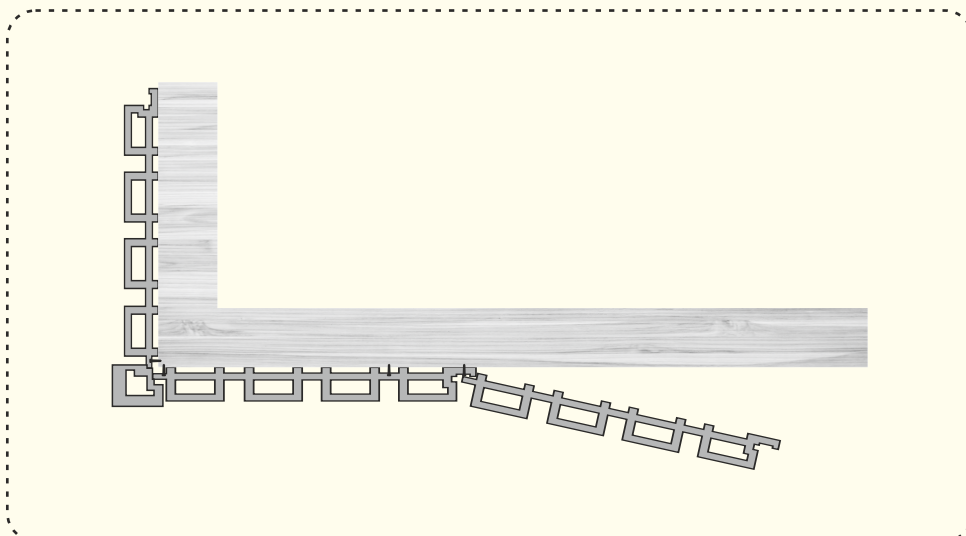

4

Cut the last board to fit to the end of the wall, if there is no screw channels after cut, put screw to the last groove part of the cladding board  
Using the end trim to cover the last board. Screw channel face to other side of the batten board.

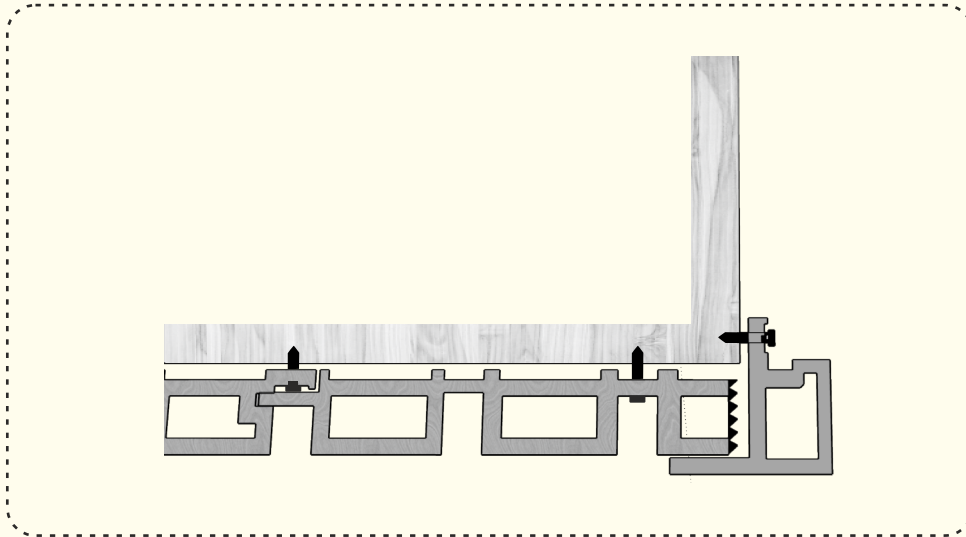

5

When you reach the internal corner  
Cut each side of the wall cladding boards to fit to the corner, if there is no screw channel after cut the boards, put screw in to the last groove part of the cladding board.  
Make sure leaves at least 3mm gap on all the end.

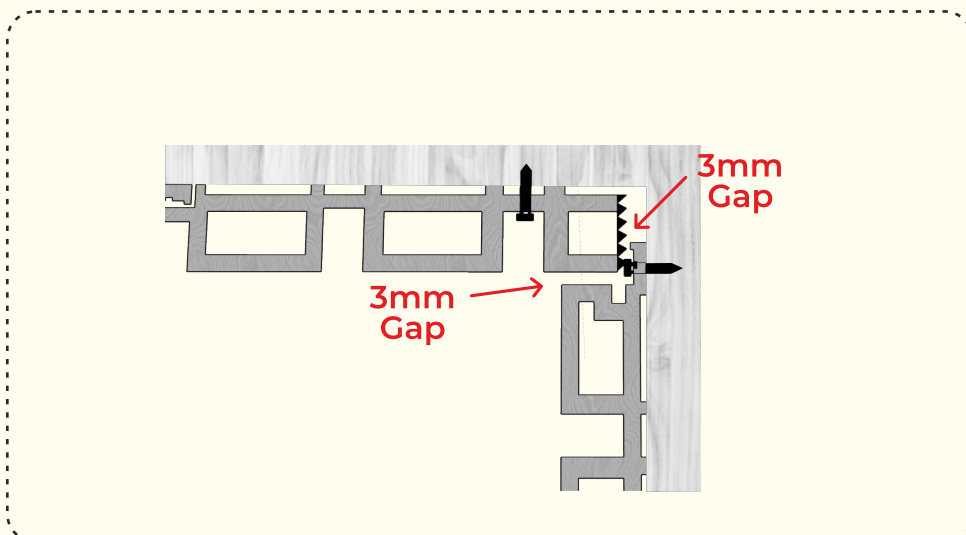

**6**

**Option 1**  
Using the start/end trim as end trim to cover the last board

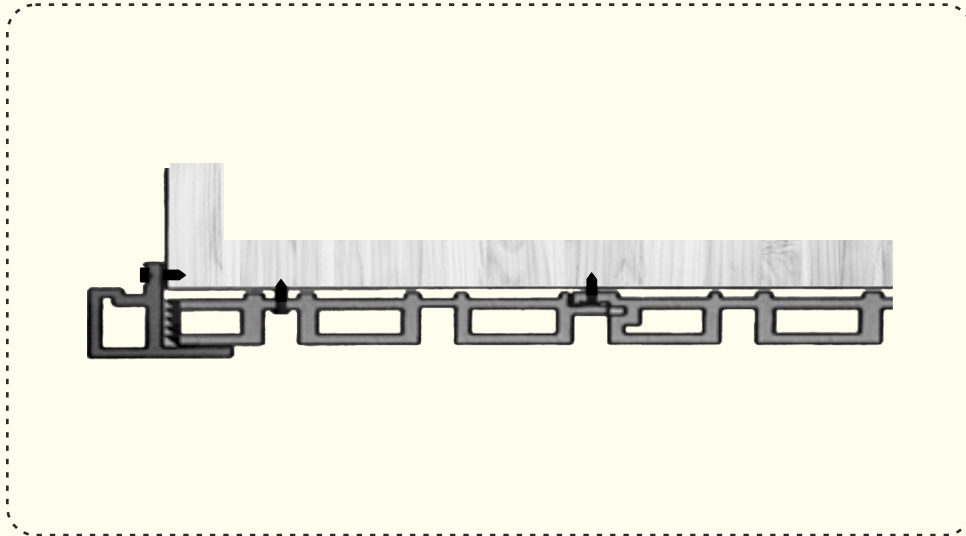

**Option 2**  
Using start/end trim as start trim to start the installation process

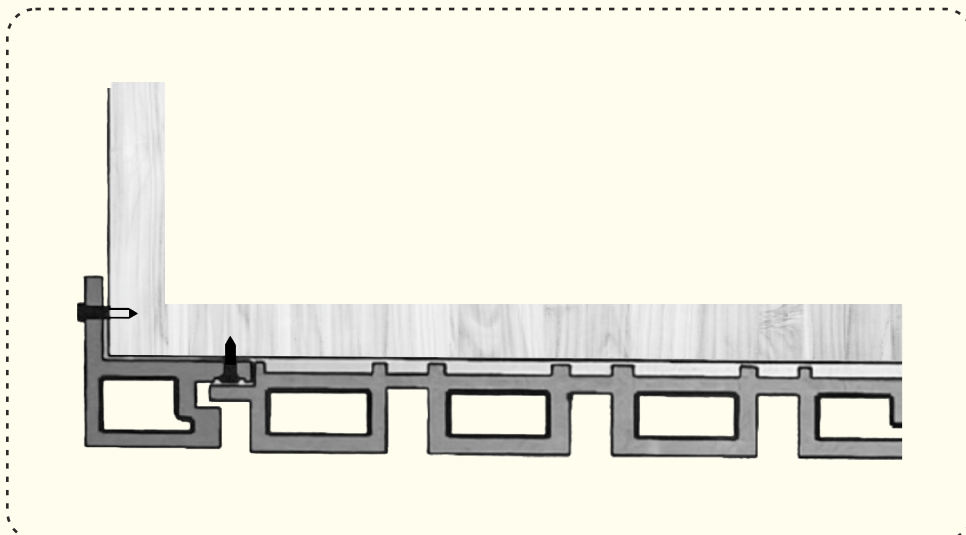

# Windows and Doors

Notes: Window Drip flashing must be installed before install of the wall cladding

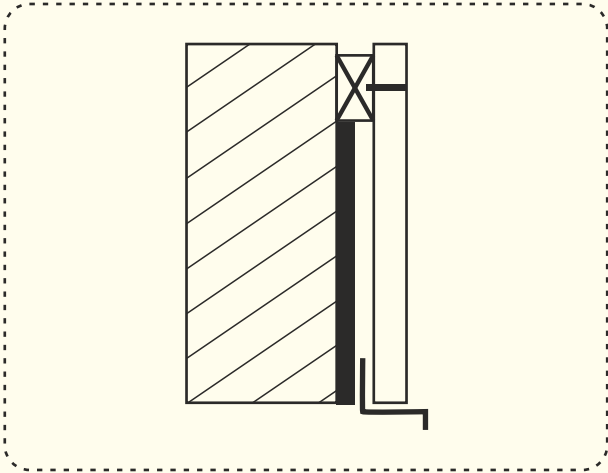

Top/Window & Door Trim can be cut down to suit the window and door reveal.  
Please Note: WoodEvo EvoClad Trims must be pre-drilled before fixing with screws

**Option 1**  
Wall cladding flat with  
window/door trim

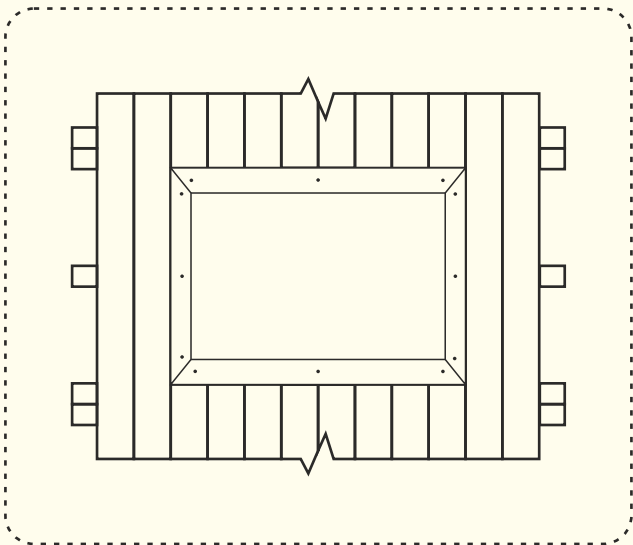

**Option 2**  
Window/door trim is on top  
of the wall cladding

